

Medicine Cabinet

Recessed Mount

INSTALLATION INSTRUCTIONS

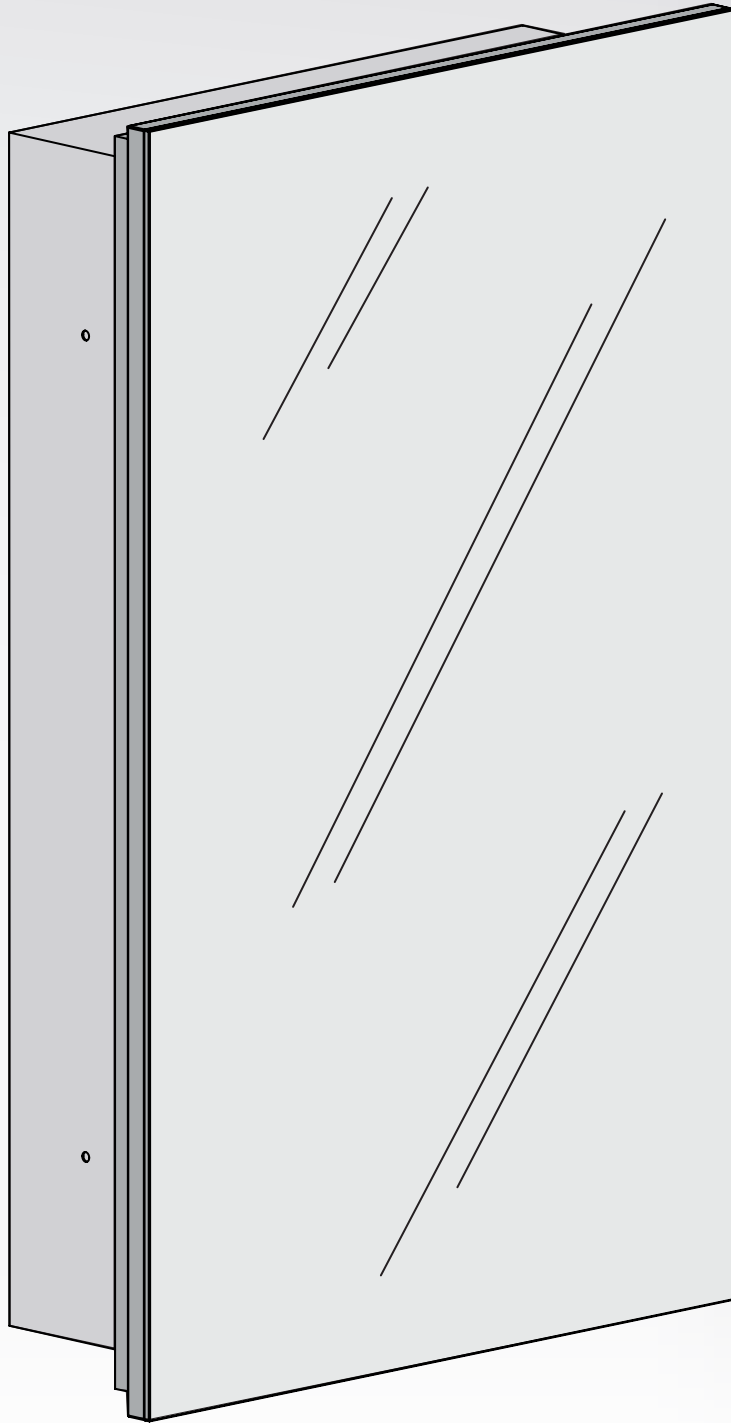

MKTD4065 - 210006/7 - ENG

For 210006 and 210007 Models



REQUIRES
TWO
PEOPLE

PLEASE READ CAREFULLY

- Read all instructions carefully.
- Protect your eyes by wearing safety goggles.
- Keep the installation area free of clutter.
- Follow each step completely before starting the next step.

IMPORTANT!

VERIFY THAT ALL PARTS ARE INCLUDED IN THE PACKAGING. IF ANY PARTS ARE MISSING, DO NOT RETURN THIS PRODUCT TO THE STORE.

FOR PARTS ASSISTANCE, PLEASE CALL 1-800-493-5263 BETWEEN 8:30 AM AND 4:30 PM EST, MONDAY TO FRIDAY. SUPPORT IS PROVIDED IN ENGLISH, FRENCH AND SPANISH.

PACKAGE CONTENTS

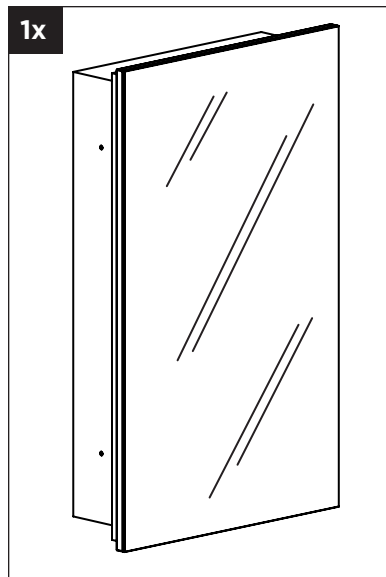

Medicine Cabinet Unit

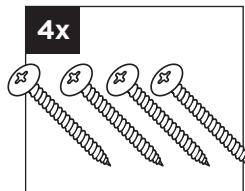

Screws

TOOLS REQUIRED (NOT PROVIDED)

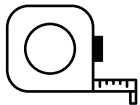

Measuring Tape



Pencil



Stud Finder

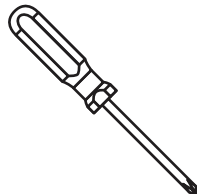

Phillips Screwdriver

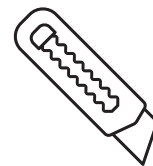

Drywall Knife



Safety Goggles

Small Level or 4' Level



WARNING: Drilling, sawing, sanding or machining wood products can expose you to wood dust, a substance known to the State of California to cause cancer. Avoid inhaling wood dust or use a dust mask or other safeguards for personal protection. For more information go to www.P65Warnings.ca.gov/wood.

STEP 1 Measure, cut and prepare the opening

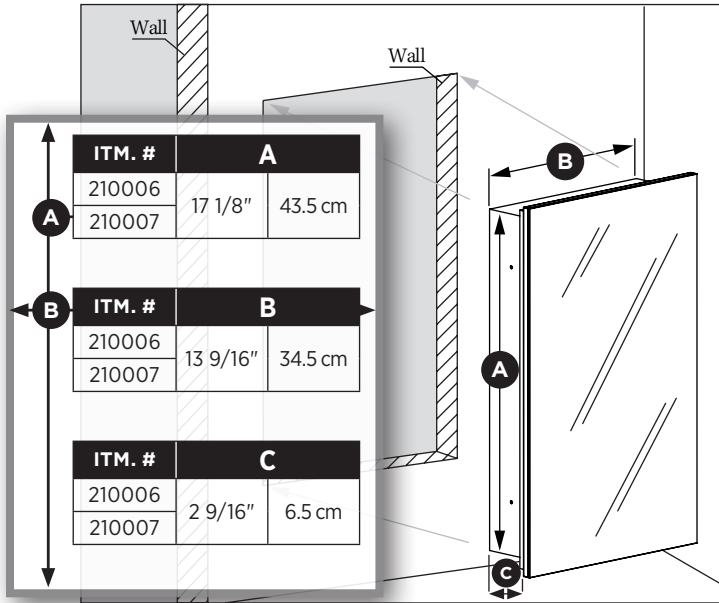

STEP 2 Fit Cabinet into opening

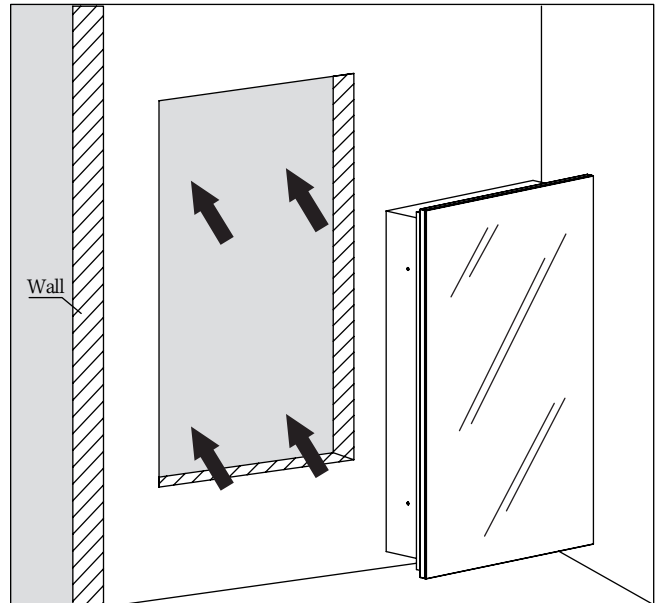

Note: Prior to cutting into the drywall, use a Stud finder to confirm that the minimum distance between studs is 14 inches. Next cut a small 4 inch square hole in drywall to look for obstructions like wires or pipes behind the drywall. It is not recommended to cut an existing stud in the wall.

STEP 3 Secure Cabinet to Studs

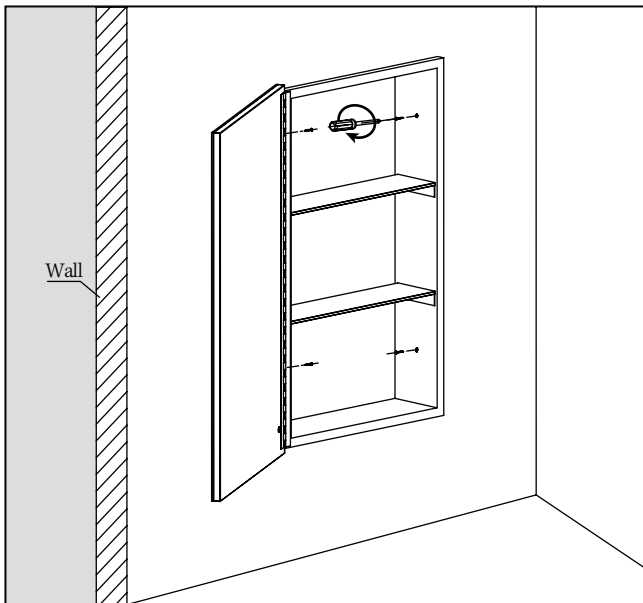

STEP 4 Installation Complete

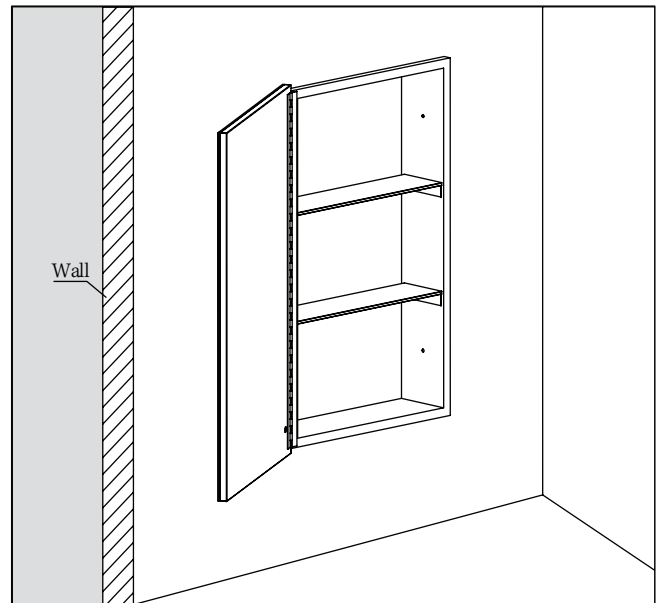

Medicine Cabinet Recessed Mount

5 YEAR LIMITED WARRANTY

Products warranted against manufacturing defects for up to five years from the purchase date. The warranty applies only to the original purchaser of the product.

If a product is determined to be defective due to a manufacturing defect, a replacement product will be supplied. The scope of the warranty is limited to replacing the product and does not include labor required to install, repair or deliver, or any costs related to removing the existing product.

This warranty is void in the event that the product is damaged in transit, or if damage or failure is caused by abuse, misuse, storage of products in an improper environment, abnormal usage, faulty installation, failure to follow installation instructions, damage in an accident, improper maintenance, or any repair.

We reserve the right to inspect any claim prior to issuing credit.